

**M12 MALE,0° SHIELDED, D CODED, ETHERNET**

PUR 2x2xAWG22 shielded green UL/CSA 50m

Ethernet CAT5

Male straight

M12, 4-pole

D-coded

shielded

Further cable lengths on request.

Plastic housings with good resistance against chemicals and oils.

The resistance to aggressive media should be individually tested for your application. Further details on request.

Transmission properties with channel transmission up to 100 m

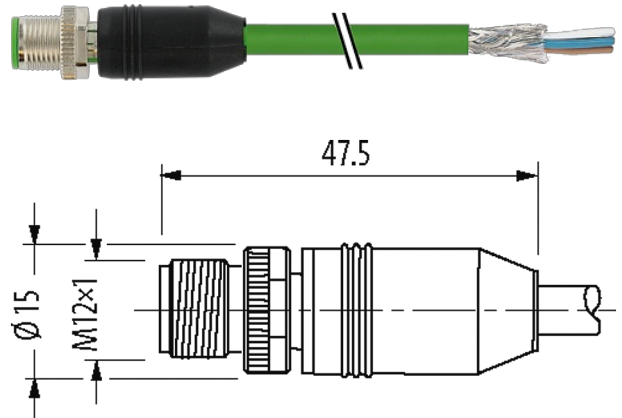
**Illustration**

Product may differ from Image

**Approvals**

\* only for products with UL/CSA approved cable

cCSAus

**More Info**

EtherNet/IP

**Form**

Form 14541

**Cables**

No./diameter of wires	2 × 2 × AWG22/7 (0.355)
Wire isolation	PE (wh, ye, bl, or)
Jacket Color	green
Material (jacket)	PUR (UL/CSA)
Outer Ø	6.7 mm ±5%
Bend radius (moving)	12 × outer Ø
Temperature range (fixed)	-40...+80 °C

Temperature range (mobile)	-30...+70 °C
Cable identification	794
Approval (cable)	UL (AWM-Style 20233/10578), CSA; CE
Cable weight [g/m]	75,87
Material (wire)	Cu wire, bare
Resistor (core)	max. 55 Ω/km (20 °C)
Construction (core)	7 × 0.254 mm
Diameter (core)	2 × 2 × AWG22/7 (0.355)
AWG	similar to AWG 22
Material (wire isolation)	PE
Wire-Ø incl. isolation	1.55 mm ±5%
Color/numbering of wires	wh, ye, bl, or
Shield	yes
	min. 85%
Material (jacket)	PUR
Outer-Ø (jacket)	6.7 mm ±5%
Color (jacket)	green
chemical resistance	good resistance to oil, gasoline and chemicals
thermal resistance	flame retardant
Nominal voltage	300 V
Temperature range (fixed)	-40...+80 °C
Temperature range (mobile)	-30...+70 °C
Bend radius (fixed)	6 × outer Ø
Bend radius (moving)	12 × outer Ø

#### Technical Data

Operating voltage	max. 60 V DC
Operating voltage (only UL listed)	max. 30 V DC
Rated surge voltage	1.5 kV
Operating current per contact	max. 4 A
Material group	IEC 60664-1, category I
Transfer parameters	CAT5, Class D (ISO/IEC 11801:2002), (EN 50173-1)
Transfer rate	up to 100 Mbit/s full duplex
Coding	D-coded
Locking of ports	Screw thread (M12×1 mm) recommended torque 0.6 Nm, self-securing
Compression gland	M12 (SW13)
Protection	IP65, IP66K, IP67 inserted and tightened (EN 60529)
Locking material	Zinc die casting, matte nickel plated
Material	PUR
suitable for corrugated tube (internal Ø)	without

#### General data

Standards	DIN EN 61076-2-101 (M12)
Pollution Degree	3
Temperature range	-25...+85 °C, depending on cable quality

#### Commercial data

country of origin	DE
customs tariff number	85444290
EAN	4048879407694
eClass	27061801
Packaging unit	1

#### Sketch

*stay connected*

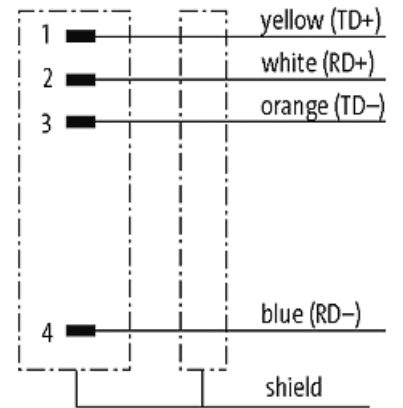

Male

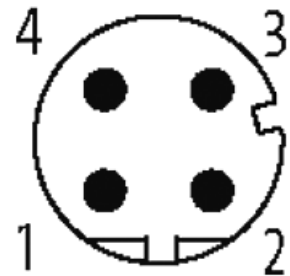

Product may differ from Image